



CE RoHS

Adjustable Bail for Surface Mounting



130W Unique led high bay light Specification

Dimensions

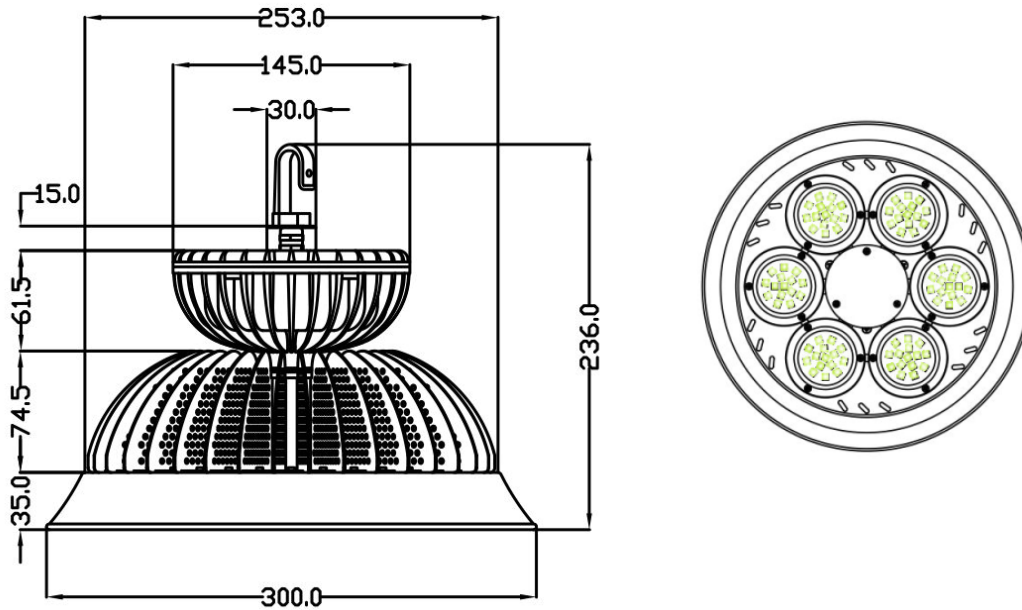

Unit: mm

Applications

The Gorgeous Lighting led high bay light was design to replace conventional lighting in a wide variety of industry industrial applications, indoor as well as outdoor spaces. Ideally it is used in warehouses, factories and other applications with mounting heights ranking from 6-18 meters and ambient environment between -25°C and +50°C. With its dimming feature, the unique LED high bay light allows the user to reduce power consumption and easily adapts its light output to the specific working situation.

Features & Benefits

- 3~5 years full performance warranty
- Replace 290W Philips HPS lamp.
- Low power consumption
- Instant on/off operation
- Universal input 100-260 V, 50/60 Hz
- Superior color rendering index compared to HID light source
- Mercury free
- L70 rated for 50.000 hrs. @ 25°C (\leq 30% lumen depreciation)

HB1405-01130W

General Charaterics

Rated Avg. Life	50,000Hrs
Main Application	High bay/Low bay/Flood
Dimming Function	Dimmable
Body Materials	Aluminum Alloy
Finish Color Availability	Black and Customizable
Warranty	3~5 Yrs.
Mounting Method	Hook + Additional Safety Cord

Light Technical Characteristics

LED Chip Information	Epistar 5050
Quantity of LED Chips	108 pcs
Color Temperature	3000~6000K
Initial Lumens	15,600lm
Luminous Efficacy	120lm/W
Lumens Depreciation (50,000Hrs)	10%
Beam Angle	45/70/90/110 Degree
CRI	75

Electrical Characteristics

Watts	130W
Lamp Voltage	AC90-300V
Typ. Forward Current	350mA
Ignition Time	<1Sec.
Driver Brand	Meanwell
Driver PF Value	≥0.95
Nominal Frequency	50/60Hz

Environmental Characteristics

RoHS

Product Data

Product Number	HB1405-01130W
Size	ø30*24cm
Net Weight	2.57kg

Approvals

IP Rating	65
Insulation Class	I
Permissible Ambient Temperature	-30~60°C
Standard	
Certification	CE, EMC,LVD, (UL, cUL, SAA pending)

Accessories

Aluminum Shield	40/70/90 degree
Acrylic Diffuser	Available
Adjustable Bail for Surface Mounting (Flood Light)	Available

Packing list

Pieces per Sku	1
Skus/Case	1
SKU Volume	34*34*23cm
Case Volume	34*34*23cm
CBM	0.026588
Gross Weight	4.3KG
Volume Weight	6.37KG
SKUs/20GP	810
SKUs/40GP	1782
SKUs/40HQ	1980

Light Distribution Curve

45 degree len

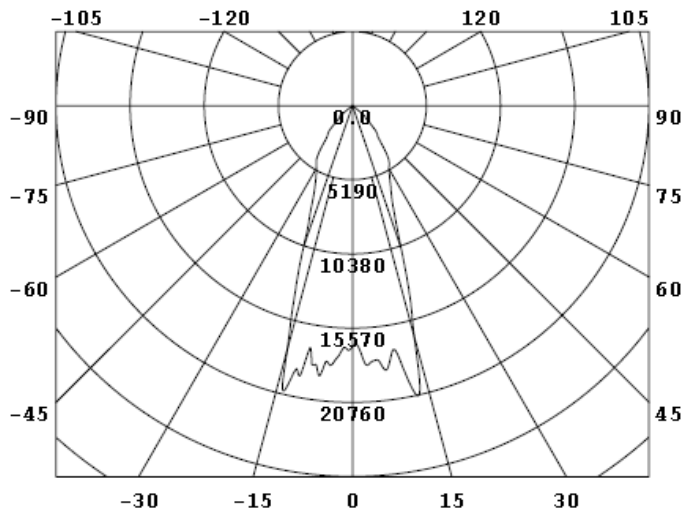

Luminous intensity

45 degree Len

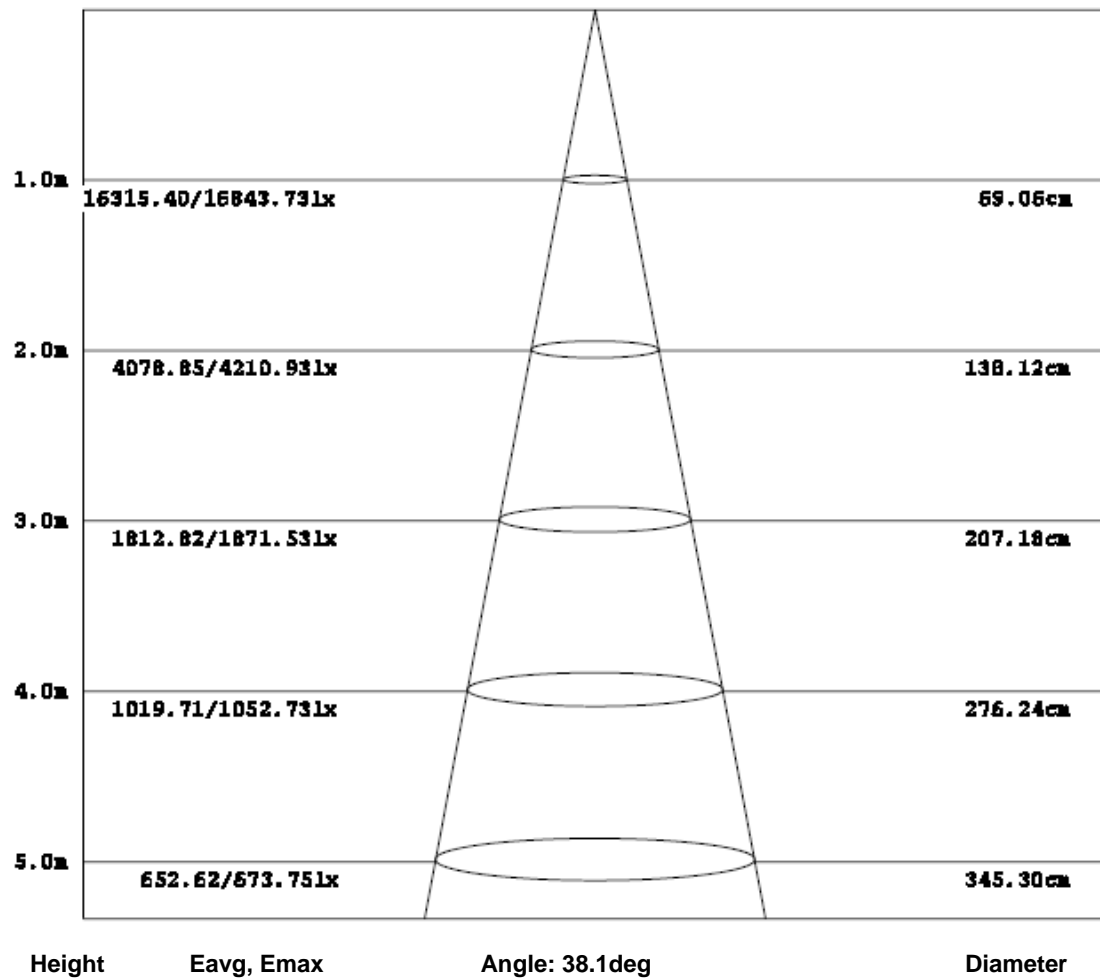

Light Distribution Curve

70 degree lens

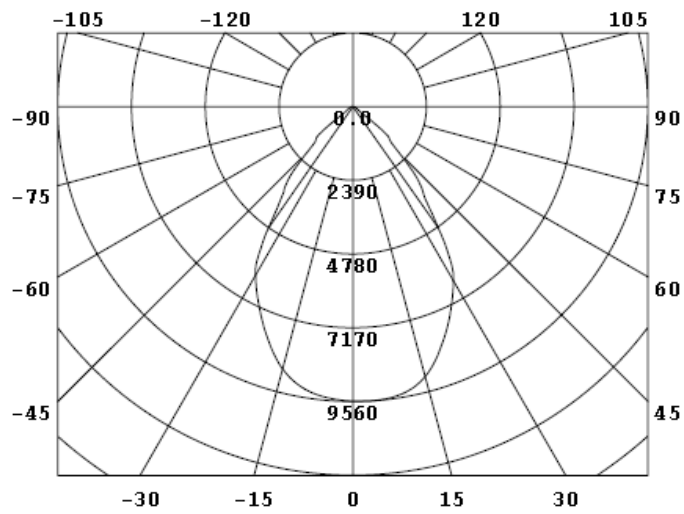

Luminous intensity

70 degree Len

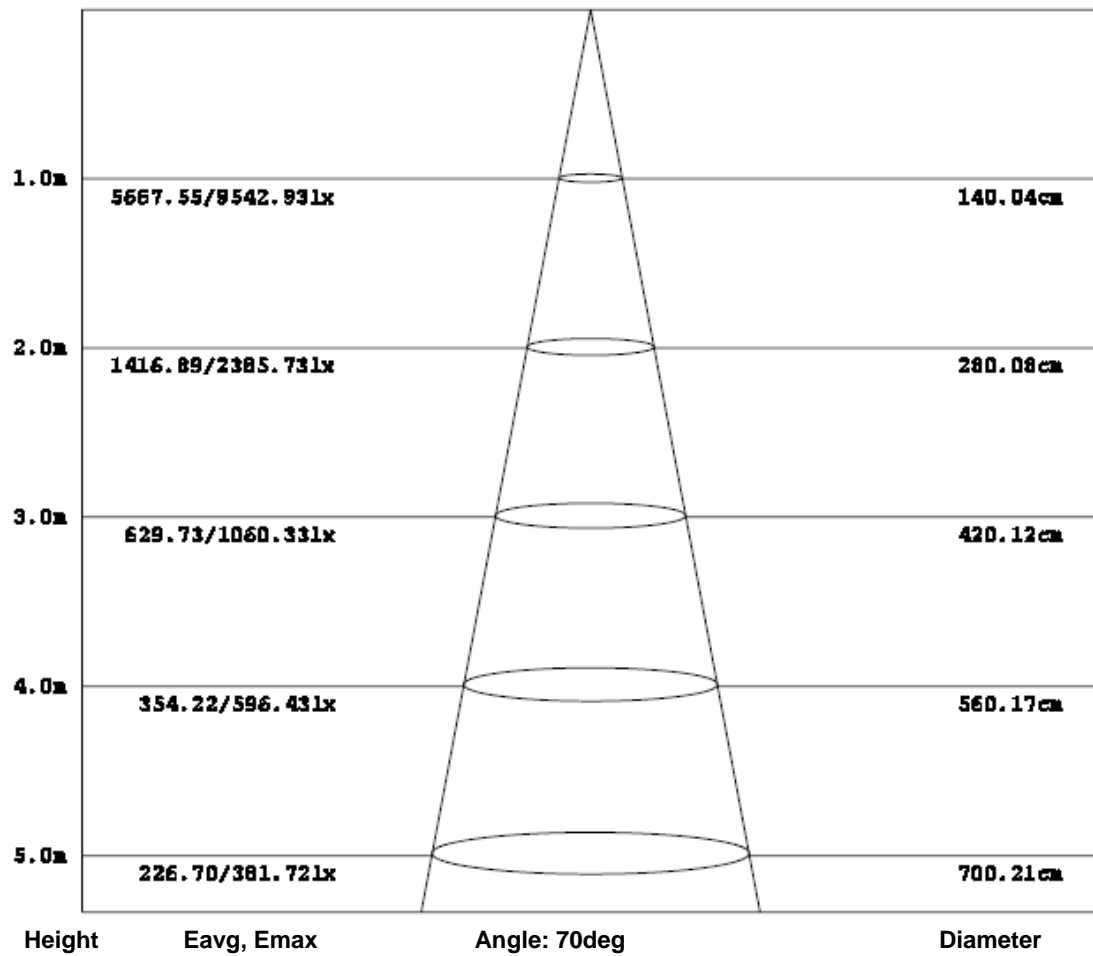

Light Distribution Curve

75 degree len

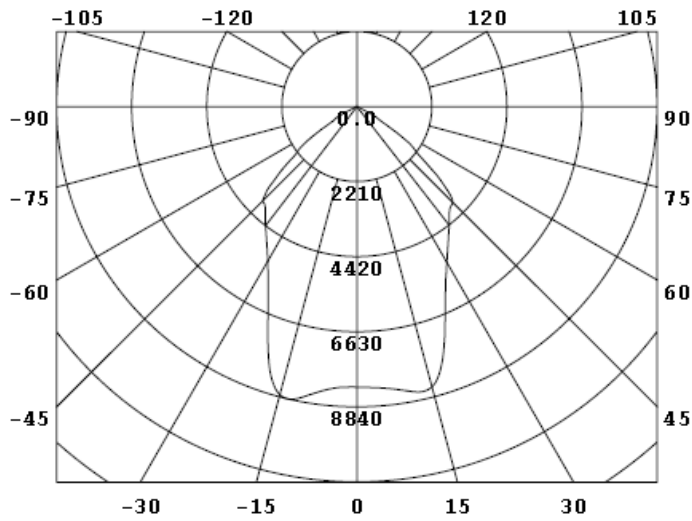

Luminous intensity

75 degree Len

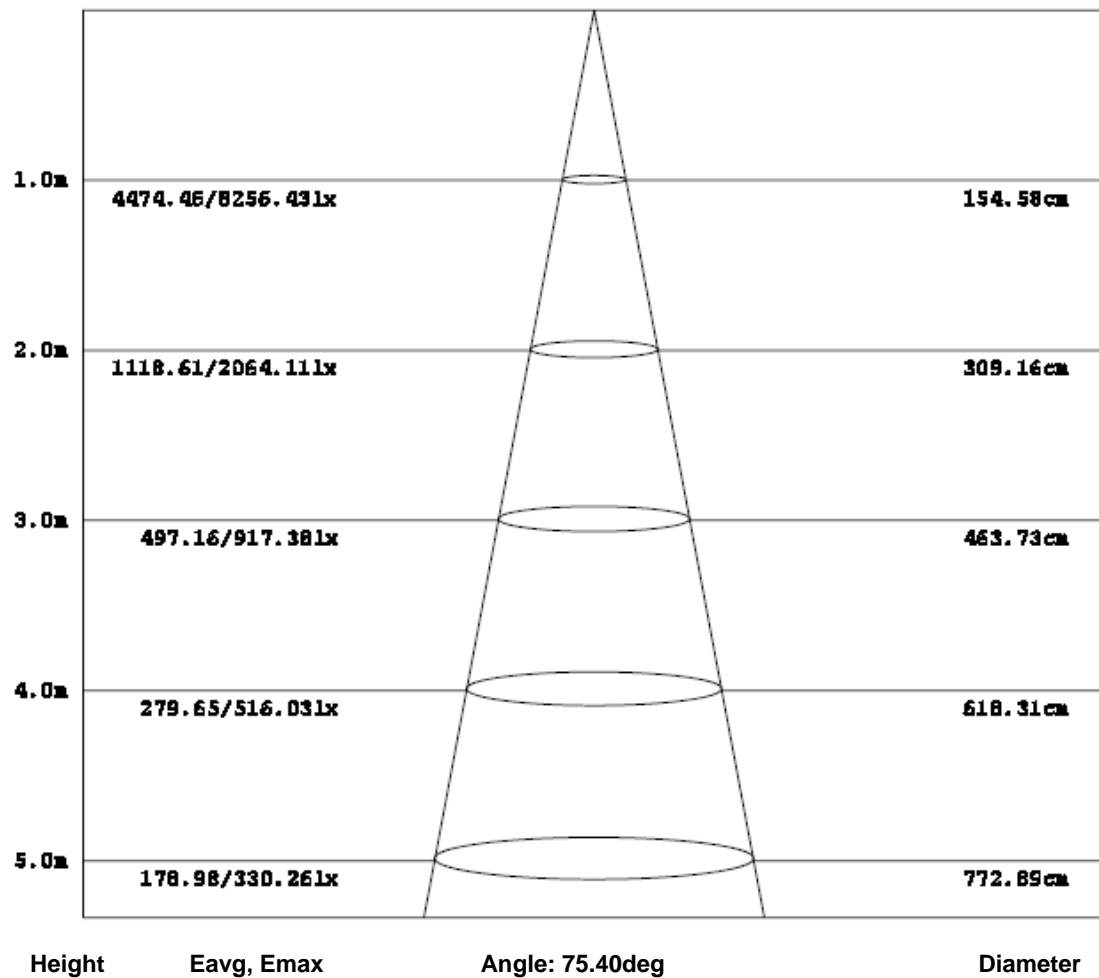

Light Distribution Curve

110 degree len

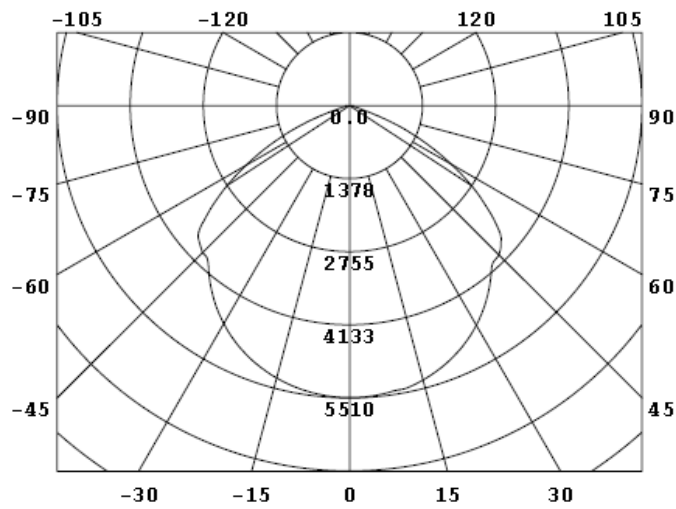

Luminous intensity

110 degree Len

